

# INDICATOR LIGHTS

(BUILT-IN LED / NEON )

TYPE : IL.12

ISSUE - PIS/IL.12

DATE : 01.10.12

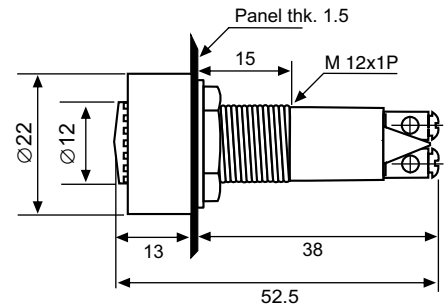
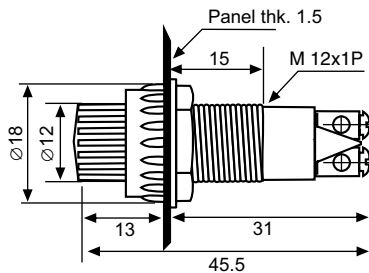
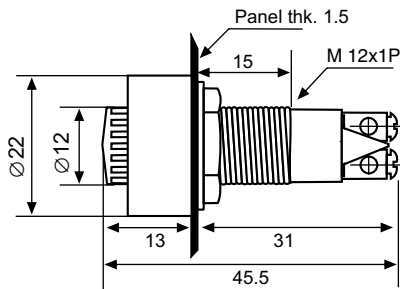
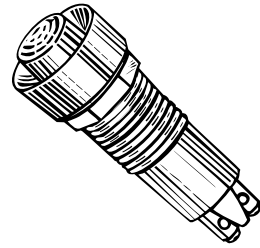
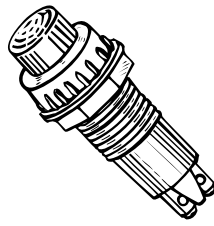
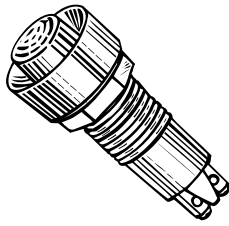

## SPECIFICATIONS

### MECHANICAL

MAIN HOUSING : NYLON  
 LENS MATERIAL : ACRYLIC  
 LENS COLOUR : RED, GRN., AMB., CLR., BLU.  
 REFLECTOR : ABS CHROME PLATED  
 HEX. NUT : NYLON  
 TERMINAL : BRASS Ni PLATED  
 CONNECTION : SCREW  
 WEIGHT : 10 GRAMS APPROX.

## PANEL CUT OUT & MIN. SPACING

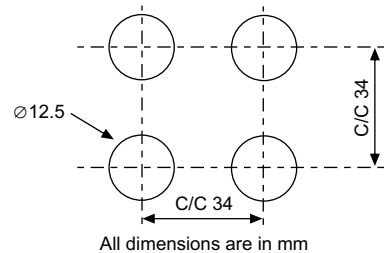

## ELECTRICAL

LAMP	RATED VOLTAGE	MIN. OPERATING VOLTAGE	CURRENT DRAWN
LED Super Bright	12V DC	4.34V	10.17mA
	24V DC	7.95V	10.48mA
	48V DC	17.73V	9.47mA
	220V AC	24.00V	2.00mA
Neon(6mm)	110V AC	71.90V	1.74mA
	220V AC	85.60V	2.46mA

Voltage Breakdown : > 1000 V AC (Terminal to Housing)

Insulation Resistance : > 1000 MΩ @ 500 V DC

## ORDERING CODE

SERIES	LENS COLOUR	RATED VOLTAGE		LENS HOLDER TYPE
		LED	NEON	
IL.12	R - RED	1 - 12VDC	5 - 110VAC	1-REFLECTOR 2-KNURLED
	G - GREEN	2 - 24VDC	6 - 220VAC	
	A - AMBER	3 - 48VDC		
	C - CLEAR	4 - 220VAC		
	B - BLUE			

→ IL.12 - R - 2 - 1 ←

Manufactured by:

**piri electrols pvt. ltd.**

A-28, Royal Industrial Estate, Naigaum Cross Road, Wadala, Mumbai 400031. INDIA.

☎ (022) 2412 8342/43 • Fax: (022) 2414 9077 • E-Mail : piri electrols@gmail.com • Website : www.piri electrols.com

